

GARANZIA 5 ANNI
GUARANTEE 5 YEARS
GARANTIE 5 ANS
GARANTIE 5 JAHRE
GARANTIA 5 AÑOS



caleido®
design radiators



Design by James Di Marco

flora collection

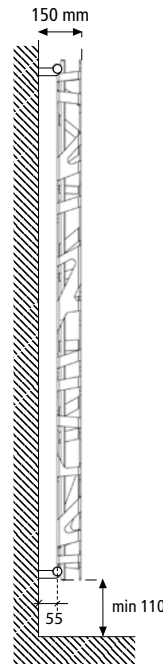
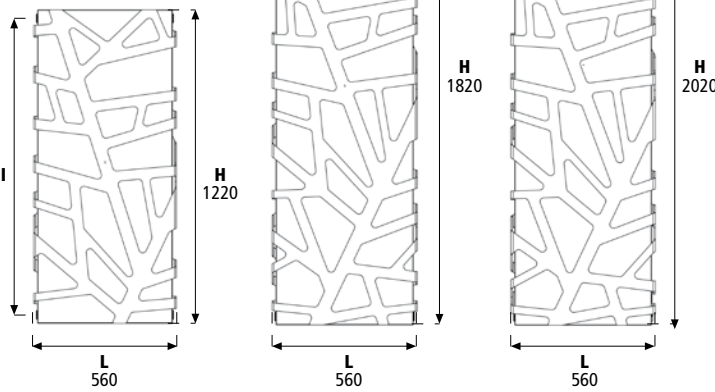
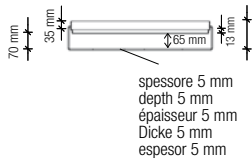

Interasse dal centro foro al muro 55 mm.
Distance between hole center and wall 55 mm.
Distance du centre du trou au mur 55 mm.
Abstand zwischen Lochsmitte und Wand 55 mm.
Distancia entre el centro del agujero y el muro 55 mm.

I radiatori sono completi di kit di fissaggio a parete e valvola di sfiato.
Pressione di collaudo: 5,2 bar - Pressione di esercizio: 4 bar.
Materiale: acciaio al carbonio + metacrilato.

The radiators are equipped with a kit for fixing them to the wall and with an exhaust valve.
Testing pressure: 5,2 bar - Working pressure: 4 bar. Material: carbon steel + Acrylic.

Les radiateurs sont munis d'un kit de fixation murale et d'une soupape de décompression.
Pression d'essai: 5,2 bars - Pression d'exercice: 4 bars. Matière: Acier au charbon + Acrylic.

Die Heizkörper sind mit Wandbefestigungsset und Luftventil ausgerüstet.
Prüfungsdruck: 5,2 bar Betriebsdruck: 4 bar. Stoff: Kohlenstoffstahl + Acrylic.

Los radiadores están provistos de kit de fijación a la pared y de válvula de desahogo.
Presión de ensayo: 5,2 bar - Presión de trabajo: 4 bar. Material: Acero de carbono + Acrylic.



Flora disponibile anche in versione solo elettrica o mista, consultare il listino radiatori elettrici.
Flora available also in electric version or dual energy version, please see our electric radiators price list.
Flora disponible dans la version seulement électrique ou dans la version mixte, voir le tarif radiateurs électriques.
Flora in elektrischer Ausführung oder in gemischter Ausführung verfügbar, bitte sehen Sie die elektrische Heizkörper-Preisliste.
Flora puede ser instalado también en versión solo eléctrica o en versión mixta consultar el listino de precios Versión eléctrica.

Interasse Centrale 50 mm **a richiesta.**
Central distance between centers 50 mm **on request.**
Entraxe centrale 50 mm **sur demande.**
Mitteanschluss 50 mm **Auf Anfrage.**
Distancia entre centros de 50 mm, **bajo pedido.**

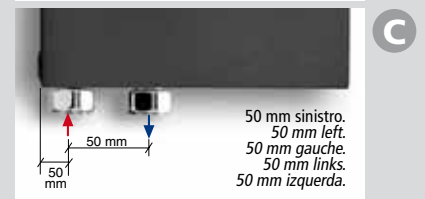
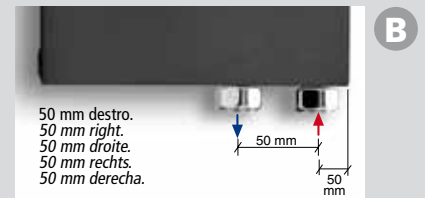
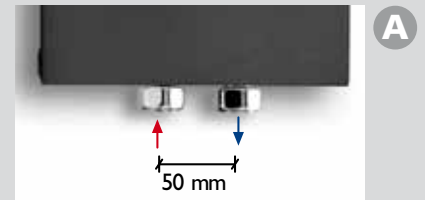

Allacciamento dal basso **a richiesta.**
Bottom connection **on request.**
Branchement par dessous **sur demande.**
Anschluss von unten **Auf Anfrage.**
Conexión por abajo **bajo pedido.**

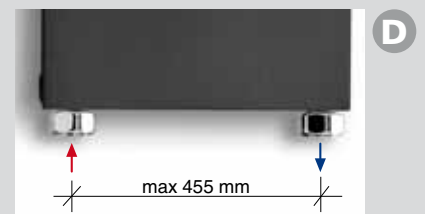

Allacciamenti possibili.
Possible connections.
Branchements possibles.
Mögliche Anschlüsse.
Empalmes standard.

A richiesta, il modello Flora può essere previsto per il montaggio in orizzontale con maggiorazione del 7%
On request Flora can be produced for being mounting horizontally with 7% price surcharge
Sur demande Flora peut être prévu pour l'installation en horizontal avec majoration du prix du 7%
Auf Anfrage kann Flora gefertigt werden, um es horizontal zu montieren. Mehrpreis von 7%.
Bajo pedido el modelo Flora puede ser previsto por el montaje en horizontal con aumento de 7%.



flora COMBINATION 1

ice bianco + metacrilato arancio



ICE

colore	colour	couleur	Farbe	color
bianco puro opaco RAL 9010	pure white matt RAL 9010	blanc pur mat RAL 9010	mattes reines Weiß RAL 9010	blanco puro mate RAL 9010

Metacrilato / Acryl

colore	colour	couleur	Farbe	color
arancio	orange	orange	orange	anaranjado

$$\text{Watt} = \text{Kcal/h} \div 0,860$$

$$\text{Kcal/h} = \text{Watt} \times 0,860$$

codice code code code Codigo	altezza height hauteur hoehe altura	larghezza width breite largeur longitud	interasse distance between bars entraxe achsabstand centros	peso weight poids gewicht peso	output 75/65-20 watt	output 55/45-20 watt	output 55/45-24 watt
	H mm	L mm	I mm	kg	Δt50	Δt30	Δt26
FFL125301	1220	560	1160	25	608	320	268
FFL185301	1820	560	1760	38	839	442	369
FFL205301	2020	560	1960	43	903	473	394

La tonalità di colore del metacrilato è indicativa.

The Acrylic color hue may change slightly.

La tonalité de la couleur du Acrylic est indicative.

Der Acrylic Farbton ist richtungsweisend.

La tonalidad del color del Acrylic es indicativa.

flora COMBINATION 2

ice satinato + metacrilato arancio



ICE

colore	colour	couleur	Farbe	color
satinato	satinated	satiné	satiniert	satinado

Metacrilato / Acryl

colore	colour	couleur	Farbe	color
arancio	orange	orange	orange	anaranjado

$$\text{Watt} = \text{Kcal/h} \div 0,860$$

$$\text{Kcal/h} = \text{Watt} \times 0,860$$

codice code code code Codigo	altezza height hauteur hoehe altura	larghezza width breite largeur longitud	interasse distance between bars entraxe achsabstand centros	peso weight poids gewicht peso	output 75/65-20 watt	output 55/45-20 watt	output 55/45-24 watt
	H mm	L mm	I mm	kg	Δt50	Δt30	Δt26
FFL125302	1220	560	1160	25	608	320	268
FFL185302	1820	560	1760	38	839	442	369
FFL205302	2020	560	1960	43	903	473	394

La tonalità di colore del metacrilato è indicativa.

The Acrylic color hue may change slightly.

La tonalité de la couleur du Acrylic est indicative.

Der Acrylic Farbton ist richtungsweisend.

La tonalidad del color del Acrylic es indicativa.



flora COMBINATION 3

ice bianco + metacrilato rosso



ICE

colore	colour	couleur	Farbe	color
bianco puro opaco RAL 9010	pure white matt RAL 9010	blanc pur mat RAL 9010	mattes reines Weiß RAL 9010	blanco puro mate RAL 9010

Metacrilato / Acryl

colore	colour	couleur	Farbe	color
rosso	red	rouge	rot	rojo

$$\text{Watt} = \text{Kcal/h} \div 0,860$$

$$\text{Kcal/h} = \text{Watt} \times 0,860$$

codice code code Code codigo	altezza height hauteur hoehe altura	larghezza width breite largeur longitud	interasse distance between bars entraxe achsabstand centros	peso weight poids gewicht peso	output 75/65-20 watt	output 55/45-20 watt	output 55/45-24 watt
	H mm	L mm	I mm	kg	Δt50	Δt30	Δt26
FFL125303	1220	560	1160	25	608	320	268
FFL185303	1820	560	1760	38	839	442	369
FFL205303	2020	560	1960	43	903	473	394

La tonalità di colore del metacrilato è indicativa.

The Acrylic color hue may change slightly.

La tonalité de la couleur du Acrylic est indicative.

Der Acrylic Farbton ist richtungsweisend.

La tonalidad del color del Acrylic es indicativa.



flora COMBINATION 4

ice satinato + metacrilato rosso



ICE

colore	colour	couleur	Farbe	color
satinato	satinated	satiné	satiniert	satinado

Metacrilato / Acryl

colore	colour	couleur	Farbe	color
rosso	red	rouge	rot	rojo

$$\text{Watt} = \text{Kcal/h} \div 0,860$$

$$\text{Kcal/h} = \text{Watt} \times 0,860$$

codice code code Code codigo	altezza height hauteur hoehe altura	larghezza width breite largeur longitud	interasse distance between bars entraxe achsabstand centros	peso weight poids gewicht peso	output 75/65-20 watt	output 55/45-20 watt	output 55/45-24 watt
	H mm	L mm	I mm	kg	Δt50	Δt30	Δt26
FFL125304	1220	560	1160	25	608	320	268
FFL185304	1820	560	1760	38	893	442	369
FFL205304	2020	560	1960	43	903	473	394

La tonalità di colore del metacrilato è indicativa.

The Acrylic color hue may change slightly.

La tonalité de la couleur du Acrylic est indicative.

Der Acrylic Farbton ist richtungsweisend.

La tonalidad del color del Acrylic es indicativa.



flora COMBINATION 5

ice nero + metacrilato neutro trasparente



ICE

colore	colour	couleur	Farbe	color
nero puro opaco RAL 9005	pure black matt RAL 9005	noir pur mat RAL 9005	mattes reines schwarz RAL 9005	negro puro mate RAL 9005

Metacrilato / Acryl

colore	colour	couleur	Farbe	color
neutro trasparente	neutral transparent	neutre transparente	transparent	neutro trasparente

$$\text{Watt} = \text{Kcal/h} \div 0,860$$

$$\text{Kcal/h} = \text{Watt} \times 0,860$$

codice code code Kode codigo	altezza height hauteur hoehe altura	larghezza width breite largeur longitud	interasse distance between bars entraxe achsabstand centros	peso weight poids gewicht peso	output 75/65-20 watt	output 55/45-20 watt	output 55/45-24 watt
	H mm	L mm	I mm	kg	Δt50	Δt30	Δt26
FFL125305	1220	560	1160	25	608	320	268
FFL185305	1820	560	1760	38	839	442	369
FFL205305	2020	560	1960	43	903	473	394

La tonalità di colore del metacrilato è indicativa.

The Acrylic color hue may change slightly.

La tonalité de la couleur du Acrylic est indicative.

Der Acrylic Farbton ist richtungsweisend.

La tonalidad del color del Acrylic es indicativa.



flora COMBINATION 6

ice satinato + metacrilato neutro trasparente



ICE

colore	colour	couleur	Farbe	color
satinato	satinated	satiné	satiniert	satinado

Metacrilato / Acryl

colore	colour	couleur	Farbe	color
neutro trasparente	neutral transparent	neutre transparente	transparent	neutro trasparente

$$\text{Watt} = \text{Kcal/h} \div 0,860$$

$$\text{Kcal/h} = \text{Watt} \times 0,860$$

codice code code Kode codigo	altezza height hauteur hoehe altura	larghezza width breite largeur longitud	interasse distance between bars entraxe achsabstand centros	peso weight poids gewicht peso	output 75/65-20 watt	output 55/45-20 watt	output 55/45-24 watt
	H mm	L mm	I mm	kg	Δt50	Δt30	Δt26
FFL125306	1220	560	1160	25	608	320	268
FFL185306	1820	560	1760	38	839	442	369
FFL205306	2020	560	1960	43	903	473	394

La tonalità di colore del metacrilato è indicativa.

The Acrylic color hue may change slightly.

La tonalité de la couleur du Acrylic est indicative.

Der Acrylic Farbton ist richtungsweisend.

La tonalidad del color del Acrylic es indicativa.

flora COMBINATION 7

ice bianco + metacrilato nero



ICE

colore	colour	couleur	Farbe	color
bianco puro opaco RAL 9010	pure white matt RAL 9010	blanc pur mat RAL 9010	mattes reines Weiß RAL 9010	blanco puro mate RAL 9010

Metacrilato / Acryl

colore	colour	couleur	Farbe	color
nero	black	noir	schwarz	negro

$$\text{Watt} = \text{Kcal/h} \div 0,860$$

$$\text{Kcal/h} = \text{Watt} \times 0,860$$

codice code code Code codigo	altezza height hauteur hoehe altura	larghezza width breite largeur longitud	interasse distance between bars entraxe achsabstand centros	peso weight poids gewicht peso	output 75/65-20 watt	output 55/45-20 watt	output 55/45-24 watt
	H mm	L mm	I mm	kg	Δt50	Δt30	Δt26
FFL125307	1220	560	1160	25	608	320	268
FFL185307	1820	560	1760	38	839	442	369
FFL205307	2020	560	1960	43	903	473	394

La tonalità di colore del metacrilato è indicativa.

The Acrylic color hue may change slightly.

La tonalité de la couleur du Acrylic est indicative.

Der Acrylic Farbton ist richtungsweisend.

La tonalidad del color del Acrylic es indicativa.

flora COMBINATION 8

ice satinato + metacrilato nero



ICE

colore	colour	couleur	Farbe	color
satinato	satinated	satiné	satiniert	satinado

Metacrilato / Acryl

colore	colour	couleur	Farbe	color
nero	black	noir	schwarz	negro

$$\text{Watt} = \text{Kcal/h} \div 0,860$$

$$\text{Kcal/h} = \text{Watt} \times 0,860$$

codice code code Code codigo	altezza height hauteur hoehe altura	larghezza width breite largeur longitud	interasse distance between bars entraxe achsabstand centros	peso weight poids gewicht peso	output 75/65-20 watt	output 55/45-20 watt	output 55/45-24 watt
	H mm	L mm	I mm	kg	Δt50	Δt30	Δt26
FFL125308	1220	560	1160	25	608	320	268
FFL185308	1820	560	1760	38	839	442	369
FFL205308	2020	560	1960	43	903	473	394

La tonalità di colore del metacrilato è indicativa.

The Acrylic color hue may change slightly.

La tonalité de la couleur du Acrylic est indicative.

Der Acrylic Farbton ist richtungsweisend.

La tonalidad del color del Acrylic es indicativa.

flora COMBINATION 9

ice bianco + metacrilato verde

EN 442

ICE

colore	colour	couleur	Farbe	color
bianco puro opaco RAL 9010	pure white matt RAL 9010	blanc pur mat RAL 9010	mattes reines Weiß RAL 9010	blanco puro mate RAL 9010

Metacrilato / Acryl

colore	colour	couleur	Farbe	color
verde	green	vert	grün	verde

$$\text{Watt} = \text{Kcal/h} \div 0,860$$

$$\text{Kcal/h} = \text{Watt} \times 0,860$$

codice code code Kode codigo	altezza height hauteur hoehe altura	larghezza width breite largeur longitud	interasse distance between bars entraxe achsabstand centros	peso weight poids gewicht peso	output 75/65-20 watt	output 55/45-20 watt	output 55/45-24 watt
	H mm	L mm	I mm	kg	Δt50	Δt30	Δt26
FFL125309	1220	560	1160	25	608	320	268
FFL185309	1820	560	1760	38	839	442	369
FFL205309	2020	560	1960	43	903	473	394

La tonalità di colore del metacrilato è indicativa.

The Acrylic color hue may change slightly.

La tonalité de la couleur du Acrylic est indicative.

Der Acrylic Farbton ist richtungsweisend.

La tonalidad del color del Acrylic es indicativa.

flora COMBINATION 10

ice nero + metacrilato verde

EN 442

ICE

colore	colour	couleur	Farbe	color
nero puro opaco RAL 9005	pure black matt RAL 9005	noir pur mat RAL 9005	mattes reines schwarz RAL 9005	negro puro mate RAL 9005

Metacrilato / Acryl

colore	colour	couleur	Farbe	color
verde	green	vert	grün	verde

$$\text{Watt} = \text{Kcal/h} \div 0,860$$

$$\text{Kcal/h} = \text{Watt} \times 0,860$$

codice code code Kode codigo	altezza height hauteur hoehe altura	larghezza width breite largeur longitud	interasse distance between bars entraxe achsabstand centros	peso weight poids gewicht peso	output 75/65-20 watt	output 55/45-20 watt	output 55/45-24 watt
	H mm	L mm	I mm	kg	Δt50	Δt30	Δt26
FFL125310	1220	560	1160	25	608	320	268
FFL185310	1820	560	1760	38	442	442	369
FFL205310	2020	560	1960	43	903	473	394

La tonalità di colore del metacrilato è indicativa.

The Acrylic color hue may change slightly.

La tonalité de la couleur du Acrylic est indicative.

Der Acrylic Farbton ist richtungsweisend.

La tonalidad del color del Acrylic es indicativa.



flora COMBINATION 11

ice bianco + metacrilato azzurro



ICE

colore	colour	couleur	Farbe	color
bianco puro opaco RAL 9010	pure white matt RAL 9010	blanc pur mat RAL 9010	mattes reines Weiß RAL 9010	blanco puro mate RAL 9010

Metacrilato / Acryl

colore	colour	couleur	Farbe	color
azzurro	light blue	azuré	blau	azul

Watt=Kcal/h ÷ 0,860
Kcal/h= Watt x 0,860

codice code code Code codigo	altezza height hauteur hoehe altura	larghezza width breite largeur longitud	interasse distance between bars entraxe achsabstand centros	peso weight poids gewicht peso	output 75/65-20 watt	output 55/45-20 watt	output 55/45-24 watt
	H mm	L mm	I mm	kg	Δt50	Δt30	Δt26
FFL125311	1220	560	1160	25	608	320	268
FFL185311	1820	560	1760	38	839	442	369
FFL205311	2020	560	1960	43	903	473	394

Δt50

La tonalità di colore del metacrilato è indicativa.

The Acrylic color hue may change slightly.

La tonalité de la couleur du Acrylic est indicative.

Der Acrylic Farbton ist richtungsweisend.

La tonalidad del color del Acrylic es indicativa.



flora COMBINATION 12

ice nero + metacrilato azzurro



ICE

colore	colour	couleur	Farbe	color
nero puro opaco RAL 9005	pure black matt RAL 9005	noir pur mat RAL 9005	mattes reines schwarz RAL 9005	negro puro mate RAL 9005

Metacrilato / Acryl

colore	colour	couleur	Farbe	color
azzurro	light blue	azuré	blau	azul

Watt=Kcal/h ÷ 0,860
Kcal/h= Watt x 0,860

codice code code Code codigo	altezza height hauteur hoehe altura	larghezza width breite largeur longitud	interasse distance between bars entraxe achsabstand centros	peso weight poids gewicht peso	output 75/65-20 watt	output 55/45-20 watt	output 55/45-24 watt
	H mm	L mm	I mm	kg	Δt50	Δt30	Δt26
FFL125312	1220	560	1160	25	608	320	268
FFL185312	1820	560	1760	38	839	442	369
FFL205312	2020	560	1960	43	903	473	394

La tonalità di colore del metacrilato è indicativa.

The Acrylic color hue may change slightly.

La tonalité de la couleur du Acrylic est indicative.

Der Acrylic Farbton ist richtungsweisend.

La tonalidad del color del Acrylic es indicativa.